

STANDARD EQUIPMENT

ISO standard cabin

- Cabin ROPS(ISO 12117-2)
- FOPS(ISO 10262)
- TOPS(ISO 12117)
- All-weather steel cab with all-around visibility
- Safety glass windows
- Rise-up type windshield wiper
- Sliding fold-in front window
- Sliding side window
- Lockable door
- Accessory box & Ash-tray

Centralized monitoring

- Engine speed
- Gauges
- Fuel level gauge

- Engine coolant temperature gauge
- Warning
- Fuel level
- Engine oil pressure
- Engine coolant temperature
- Hyd. oil temperature
- Low battery
- Air cleaner closing
- Fuel prefilter
- Air-conditioner & heater
- Single acting piping kit (breaker, etc)
- Door and cab locks, one key
- Radio / USB player with remote control
- Outside rear view mirror
- Fully adjustable suspension seat with seat belt

- Console box tilting system(LH.)
- Two front working lights
- Electric horn
- Battery (1 x 12 V x 100 AH)
- Battery master switch
- 12 volt power supply
- Automatic swing brake
- Removable reservoir tank
- Water separator, fuel line
- Mono boom (2.9 m, 9' 6")
- Arm (1.48 m, 4' 10")
- Track shoes (380 mm, 1' 3")
- Track rail guard
- Starting aid (air grid heater) cold weather

OPTIONAL EQUIPMENT

- Fuel filler pump (35l/min, 9.2 US gpm)
- Beacon lamp
- Double acting piping kit (clamshell, etc)
- Accumulator, work equipment lowering
- Electric transducer
- Hyundai Bio Hydraulic Oil (HBHO)

- Travel alarm
- Quick coupler
- Rubber crawler (400mm, 16")
- Long arm (1.9m, 6'3")
- Tool kit

- Operator suit
- Mechanical suspension seat with heater
- Cabin front, rear work lamp
- Lever pattern change valve
- Additional CWT (200kg, 440lb)

- * Standard and optional equipment may vary. Contact your Hyundai dealer for more information. The machine may vary according to International standards.
- * The photos may include attachments and optional equipment that are not available in your area.
- * Materials and specifications are subject to change without advance notice.
- * All imperial measurements rounded off to the nearest pound or inch.

PLEASE CONTACT

 **HYUNDAI**
CONSTRUCTION EQUIPMENT

Head Office (Sales office)
First tower, 55, Bundang-ro, Bundang-gu, Seongnam-si, Gyeonggi-do, Korea

MOVING YOU FURTHER

Robex

60CR-9

With Tier 4 Interim Engine installed



*Photo may include optional equipment.

Pride at Work

Hyundai Construction Equipment strives to build state-of-the-art earthmoving equipment to give every operator maximum performance, more precision, versatile machine preferences, and proven quality. Take pride in your work with Hyundai!

Robex 60CR-9

Machine Walk-Around

Rugged Upper and Lower Frame

The upper frame is designed with optimum structural integrity to absorb impact and operational stress. The x-style center frame and reinforced box section track frame provide exceptional strength and longer service life to withstand tough working conditions.

Engine Technology

The fuel efficient, Tier 4 interim certified Yanmar 4TNV98 engine provides proven, reliable power. This engine is electronically controlled for optimum fuel to air ratio and clean, efficient combustion and provides low noise, anti-restart features.

Efficient Control System

All control devices are arranged for higher productivity and improved operator comfort. Efficient and ergonomic controls allow an operator to control the machine in any working environment. A safety lever on the left-side console is provided to prevent exiting the cabin while hydraulic controls are live.

Advanced Hydraulic System

The R60CR-9's advanced hydraulic system includes an arm flow summation system, boom holding system and a swing parking brake for smooth and fine control. Other valuable features include a hydraulic damper in the travel pedal, and a hydraulically lubricated swing reducer with a leak-free grease chamber.

Comfortable and Durable Cabin

The cabin is roomy and ergonomically designed, for reduced noise and good visibility. The cabin frame meets international standard TOPS, ROPS, FOPS ensuring operator safety.

Operator Convenience

Convenient operator features include a suspension seat, excellent visibility, and variable storage space for advanced operator comfort. The newly designed LED cluster provides current information, including engine RPM, engine coolant, fuel level, and electric components. A hydraulic function safety lock and auto diagnostic features are also available. lock and failure diagnosis functions are also integrated. A powerful air conditioning system and Radio & USB player contribute to a productive work environment.

Easy and Simple Maintenance

Wide open access of doors, covers, hoods is designed for easier maintenance. The air cleaner and centralized grease fittings are also integrated for easy service.

Extended Life of Components

Long life components and wear parts, including hydraulic filters, oil, shims, and bushings, help to reduce operating costs.



*Photo may include optional equipment.

Preference

The powerful and sophisticated R60CR-9 provides the operator with a large, comfortable operating environment and an ergonomically designed suspension seat with arm rests for an enhanced operating experience. For additional convenience, precision designed joystick controllers and an easy to read monitor provide the operator with quick access to information and machine control.



*Photo may include optional equipment.

Operator Comfort

The R60CR-9 operator's cab is designed for a comfortable operating experience. An ergonomically designed suspension seat, adjustable arm rests and a spacious environment helps to minimize operator fatigue. Control levers are easily accessible and an instrument display is provided to keep the operator informed of pertinent machine information.

1. A large upper roof glass provides additional visibility and a roller shade is provided to reduce glare and sunlight.
2. An advanced audio system with AM/FM stereo with USB player input, plus remotely located control is perfect for listening to music favorites.
3. A hands-free cell phone function is available for safe and convenient phone use.
4. Ergonomically designed joysticks reduce operator fatigue during the work day.
5. Accel dial with LED lamp is easy to control and recognizable in darkness.
6. Multiple storage compartments are available for additional convenience.



1 Roller shade 2 Radio & USB player with remote control 3 Hands-free cell phone 4 Joystick 5 Accel dial with LED lamp 6 Storage compartment

Enhanced Cabin

Hyundai's R60CR-9 is equipped for convenience and productivity.

1. Adjustable position window prevents window movement while operating.
2. A sliding fold-in front window is easily opened and safely stored in an open position to improve ventilation and visibility.
3. A tilt-up left side control console provides easier entrance and exit from the cab.
4. A power climate control system provides the operator with optimum air temperature.

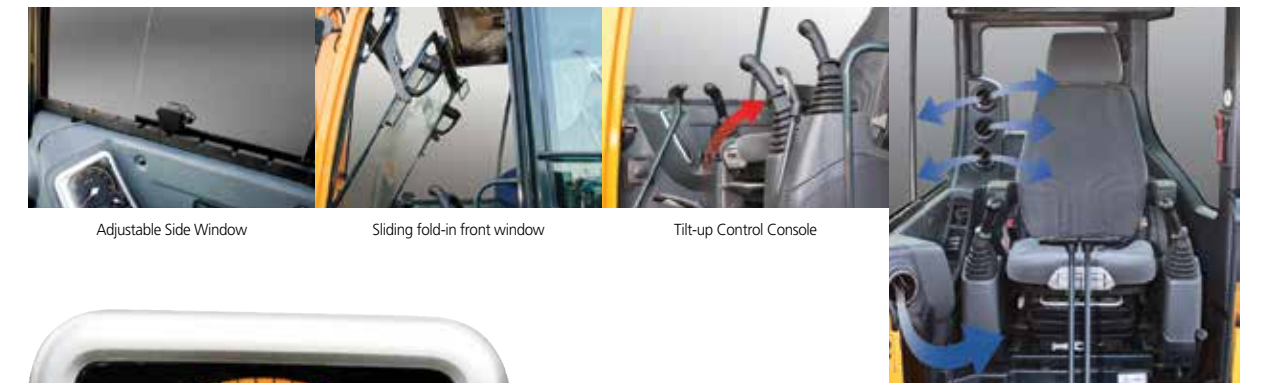

1 Adjustable Side Window 2 Sliding fold-in front window 3 Tilt-up Control Console 4 Ventilation system



Wide Cabin with Excellent Visibility

The newly designed cabin was conceived for more space, a wider field of view and operator comfort. Special attention was given to a clear, open and convenient interior with plenty of visibility on the machine surroundings and the job at hand. This well balanced combination of precision aspects put the operator in the perfect position to work safely and securely.



Operator - Friendly Cluster

The advanced new LED cluster allows the operator to select his personal machine preferences. The monitor displays engine rpm, engine oil temperature, water temperature and information for all electronic devices. Button selections are provided for auto idle mode, max power mode, and travel speed. A security feature is also provided to prevent the machine from starting without a proper password.

Precision & Performance

Innovative hydraulic system technologies make the R60CR-9 excavator fast, smooth and easy to control. Also R60CR-9 is designed for maximum performance to keep the operator working productively.



*Photo may include optional equipment.



Boom Swing

The R60CR-9's boom swing function is designed for efficient work in congested residential and urban areas. The boom can be offset left or right within an operating range. Plus, increased swing torque provides enhanced operating capability on the slope.

Improved Hydraulic System

Optimized matching between the joystick and main control valve improves fine control and smoothness of operation. An arm flow summation system provides energy savings, reduced cavitation and increased speed. To improve safety and avoid boom drift the R60CR-9 is equipped with an integrated boom holding system.

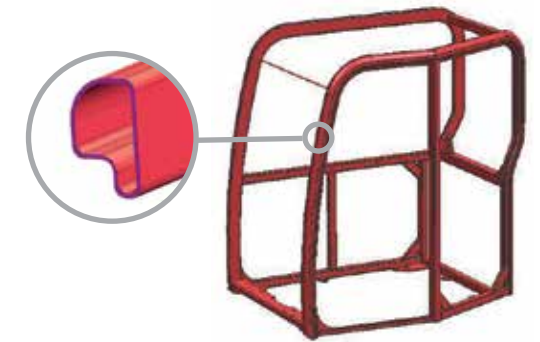

Structure Strength

The R60CR-9 cabin structure has been fitted with stronger but slimmer tubing for added safety and improved visibility. Low-stress, high strength steel is integrally welded to form a stronger, more durable upper and lower frame. Structural integrity was tested by way of FEM (Finite Elements Method) analysis and long-term durability tests.



Zero-tail Swing

R60CR-9's short tail swing radius allows the operator work in confined areas like close to buildings on roadways, and in urban areas. This compact radius design provides easy and efficient operation in any limited space work environment.



Yanmar 4TNV98

The Highest Engine Power in its Class

Yanmar 4TNV98 engine provides 20.5 kgf.m (148 lbf.ft) of maximum torque with 57 HP at 2,400rpm of rated power. This means the R60CR-9 runs with the most power in its class, giving you more power to get the job done.

Profitability

R60CR-9 is designed to maximize profitability through improved efficiencies, enhanced service features and longer life components.



Improved Durability

The R60CR-9's boom cylinder & dozer cylinder cover provide added protection on the tough working condition.



Easy Change Air Cleaner

The R60CR-9 is equipped with a durable plastic air cleaner designed for easy maintenance.



Centralized Grease Fittings

A centralized lubrication bank is available for faster, easier service and maintenance.



Wide Open Engine hood

A newly designed full-open type engine hood makes service more convenient on the R60CR-9.



Tilting Cabin

R60CR-9's tiltable cabin provides the operator with convenient maintenance.

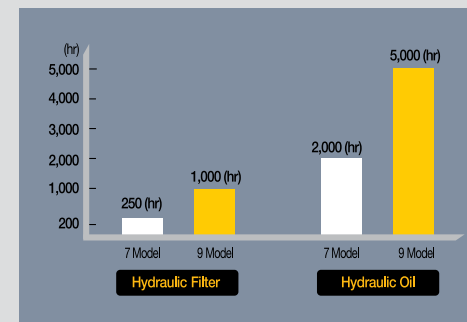

Extended Life Components

9 series excavators were designed with bushings designed for extended lube intervals (250 hrs) & polymer shims (wear resistant, noise reducing), extended-life hydraulic filters (1,000hrs), long-life hydraulic oil (5,000hrs), more efficient cooling systems and integrated preheating systems which extend service intervals, minimize operating costs and reduce machine down time.

*Photo may include optional equipment.

Specifications

ENGINE

MODEL	YANMAR 4TNV98		
Type	Water cooled, 4 cycle diesel 4 cylinders in line, direct injection, low emission		
Rated flywheel horsepower	SAE	J1995 (gross)	57 HP (42.5 kW) at 2,400 rpm
		J1349 (net)	55.2 HP (41.2 kW) at 2,400 rpm
	DIN	6271/1 (gross)	57.8 PS (42.5 kW) at 2,400 rpm
		6271/1 (net)	56 PS (41.2 kW) at 2,400 rpm
Max. torque	20.5 kgf.m (148 lbf.ft) at 1,550 rpm		
Bore X stroke	98 mm (3.86") x 110 mm (4.33")		
Piston displacement	3,319 cc (203 cu in)		
Batteries	1 x 12 V x 100 AH		
Starting motor	12V-3.0 kW		
Alternator	12V-80 Amp		

HYDRAULIC SYSTEM

MAIN PUMP	
Type	Variable displacement piston pumps
Rated flow	2 X 57.8 l/min(15.3 US gpm/12.7 UK gpm)pumps
Sub-pump for pilot circuit	Gear pump

Cross-sensing and fuel saving pump system

HYDRAULIC MOTORS	
Travel	Two speed axial piston motor with counter balance valve and parking brake
Swing	Axial piston motor with automatic brake

RELIEF VALVE SETTING	
Implement circuits	220 kgf/cm ² (3,130 psi)
Travel circuit	220 kgf/cm ² (3,130 psi) *Hyundai Bio Hydraulic Oil (HBHO) available
Swing circuit	220 kgf/cm ² (3,130 psi)
Pilot circuit	30 kgf/cm ² (430 psi)
Service valve	Installed

HYDRAULIC CYLINDERS	
No. of cylinder bore X stroke	Boom: 1-110 x 715 mm (4.3" x 28.1")
	Arm: 1-85 x 840 mm (3.3" x 33.1")
	Bucket: 1-80 x 660 mm (3.1" x 26.0")
	Boom swing: 1-95 x 527 mm (3.7" x 20.7")
	Dozer blade: 1-110 x 224 mm (4.3" x 8.8")

* Hyundai Bio Hydraulic Oil (HBHO) available

NOISE LEVEL (CAB)

NOSIE LEVELS (DYNAMIC VALVE)	
LwA	98 dB
LpA	78 dB

TRAVEL SYSTEM

Drive method	Full hydrostatic type
Drive motor	Axial piston motor, in-shoe design
Reduction system	Planetary reduction gear
Max. drawbar pull	5,300 kgf (11,700 lbf)
Max. travel speed(high) / (low)	4.0 km/hr (2.5 mph) / 2.2 km/hr (1.4 mph)
Gradeability	35° (70%)
Parking brake	Multi-wet disc

CONTROL

Pilot pressure operated joysticks and pedals with detachable lever provide almost effortless and fatigueless operation.

Pilot control	Two joysticks with one safety lever (LH): Arm swing, Boom swing (RH): Boom and bucket (ISO)
Traveling and steering	Two levers with pedals
Engine throttle	Electric, Dial type

SWING SYSTEM

Swing motor	Axial piston motor
Swing reduction	Planetary gear reduction
Swing bearing lubrication	Grease-bathed
Swing brake(option)	Multi wet disc
Swing speed	9.3 rpm

COOLANT & LUBRICANT CAPACITY

(Refilling)	liter	US gal	UK gal
Fuel tank	82.0	21.7	18.0
Engine coolant	11.0	2.9	2.4
Engine oil	11.6	3.1	2.6
Final drive(each)	1.2	0.3	0.3
Hydraulic tank	70.0	18.5	15.4
Hydraulic system	120.0	31.7	26.4

UNDERCARRIAGE

X-leg type center frame is integrally welded with reinforced box-section track frames. The undercarriage includes lubricate rollers, track adjusters with shock absorbing springs and sprockets, and track chain with triple grouser shoes.

Center frame	X - leg type
Track frame	Pentagonal box type
No. of track shoe on each side	40
No. of upper roller on each side	1
No. of lower roller on each side	5

OPERATING WEIGHT (APPROXIMATE)

Operating weight, including 2,900 mm (9' 6") boom, 1,480 mm (4' 10") arm, SAE heaped 0.18 m³ (0.24yd³) digging bucket, lubricant, coolant, full fuel tank, hydraulic tank and the standard equipment.

MAJOR COMPONENT WEIGHT	
Upperstructure	2,900 kg (6,390 lb)
Arm(with bucket cylinder)	310 kg (680 lb)

OPERATING WEIGHT		
Operating weight	Steel	5,900 kg (13,010 lb)
	Rubber	5,800 kg (12,790 lb)

·Mono boom with blade

Ground Pressure	Steel	0.36 kgf.m / cm ² (5.12 psi)
	Rubber	0.34 kgf.m / cm ² (4.83 psi)

BUCKETS

Capacity		Width		Weight
SAE heaped	CECE heaped	Without side cutters	With side cutters	
0.07 m ³ (0.09 yd ³)	0.06 m ³ (0.08 yd ³)	315 mm(12.4")	360 mm(14.2")	115 kg(255 lb)
0.18 m ³ (0.24 yd ³)	0.15 m ³ (0.20 yd ³)	670 mm(26.4")	740 mm(29.1")	170 kg(375 lb)

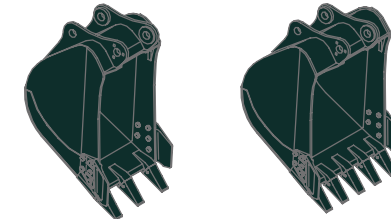

SAE heaped 0.07 m³ (0.09 yd³) 0.18 m³ (0.24 yd³)

DIGGING FORCE











Bucket	1.48m Arm	1.9m Arm
	4,170 kgf	4,170 kgf
	40.9 kN	40.9 kN
Arm	9,190 lbf	9,190 lbf
	2,700 kgf	2,280 kgf
	26.5 kN	22.4 kN
	5,950 lbf	5,030 lbf

Lifting Capacity











R60CR-9

 Rating over-front  Rating over-side or 360 degree

Boom : 2.9m (9' 6") / Arm : 1.48 m (4' 10") / Bucket : 0.18 m³ (0.24 yd³) SAE heaped / Dozer blade down

Load point height m (ft)		Load radius								At max. reach		
		2.0 m (7 ft)		3.0 m (10 ft)		4.0 m (13 ft)		5.0 m (16 ft)		Capacity		Reach
												m (ft)
4.0 m	kg					*1120	*1120			*1050	790	4.99
(13 ft)	lb					*2470	*2470			*2310	1740	(16.4)
3.0m	kg					*1180	1130			*1080	640	5.56
(10 ft)	lb					*2600	2490			*2380	1410	(18.4)
2.0 m	kg			*1890	1710	*1430	1080	*1250	740	*1120	580	5.84
(7 ft)	lb			*4170	3770	*3150	2380	*2760	1630	*2470	1280	(19.2)
1.0 m	kg			*2670	1580	*1740	1020	*1360	720	*1160	560	5.85
(3 ft)	lb			*5890	3480	*3840	2250	*3000	1590	*2560	1230	(19.2)
Ground	kg	*1980	*1980	*3000	1520	*1930	980	*1430	700	*1190	590	5.61
Line	lb	*4370	*4370	*6610	3350	*4250	2160	*3150	1540	*2620	1300	(18.4)
-1.0 m	kg	*3230	3020	*2890	1500	*1910	970			*1210	690	5.09
(-3 ft)	lb	*7120	6680	*6370	3310	*4210	2140			*2670	1520	(16.7)
-3.0 m	kg	*3960	3080	*2370	1530					*1110	990	4.12
(-10 ft)	lb	*8730	6790	*5220	3370					*2450	2180	(13.5)

Boom : 2.9 m (9' 10") / Arm : 1.48 m (4' 10") / Bucket : 0.18m³ (0.24yd³) SAE heaped / Dozer blade up

Load point height m (ft)		Load radius								At max. reach		
		2.0 m (7 ft)		3.0 m (10 ft)		4.0 m (13 ft)		5.0 m (16 ft)		Capacity		Reach
												m (ft)
4.0 m	kg					*1120	1070			1040	740	4.99
(13 ft)	lb					*2470	2360			2290	1630	(16.4)
3.0 m	kg					*1180	1060			860	600	5.56
(10 ft)	lb					*2600	2340			1900	1320	(18.2)
2.0 m	kg	*3050	*3050	*1690	1630	1430	1010	990	690	780	540	5.82
(7 ft)	lb	*6720	*6720	*3730	3590	3150	2230	2180	1520	1720	1190	(19.1)
1.0 m	kg			2250	1510	1370	960	970	670	770	520	5.84
(3 ft)	lb			4960	3330	3020	2120	2140	1480	1700	1150	(19.2)
Ground	kg	*2350	*2350	2170	1440	1330	920	950	650	810	550	5.61
Line	lb	*5180	*5180	4780	3170	2930	2030	2090	1430	1790	1210	(18.4)
-1.0 m	kg	*3600	2780	2150	1420	1320	900			940	650	5.09
(-3 ft)	lb	*7940	6130	4740	3130	2910	1980			2070	1430	(16.7)
-2.0 m	kg	*2040	*2040							*1110	920	4.12
(-7 ft)	lb	*4500	*4500							*2450	2030	(13.5)

1. Lifting capacity is based on SAE J1097, ISO 10567.











2. Lifting capacity of the Robex Series does not exceed 75% of the tipping load with the machine on firm, level ground or 87% of full hydraulic capacity.

3. The load point is a hook located on the back of the bucket.











4. (*) indicates the load limited by hydraulic capacity.

 Rating over-front  Rating over-side or 360 degree

Boom : 2.9 m (9' 10") / Arm : 1.90 m (6' 3") / Bucket : 0.18m³ (0.24yd³) SAE heaped / Dozer blade up

Load point height m (ft)		Load radius								At max. reach				
		2.0 m (7 ft)		3.0 m (10 ft)		4.0 m (13 ft)		5.0 m (16 ft)		Capacity		Reach		
												m (ft)		
4.0 m	kg									*900	670	5.45		
(13 ft)	lb									*1980	1480	(17.9)		
3.0 m	kg							*950	*950	*950	750	*940	550	5.96
(10 ft)	lb							*2090	*2090	*2090	1650	*2070	1210	(19.6)
2.0 m	kg			*1470	*1470	*1220	1070	*1100	730	*980	500	6.19		
(7 ft)	lb			*3240	*3240	*2690	2360	*2430	1610	*2160	1100	(20.3)		
1.0 m	kg			*2330	1580	*1560	1010	*1250	700	*1020	490	6.21		
(3 ft)	lb			*5140	3480	*3440	2230	*2760	1540	*2250	1080	(20.4)		
Ground	kg	*2000	*2000	*2850	1480	*1820	950	*1360	670	*1070	510	6.00		
Line	lb	*4410	*4410	*6280	3260	*4010	2090	*3000	1480	*2360	1120	(19.7)		
-1.0 m	kg	*2840	*2840	*2920	1450	*1900	930	*1360	660	*1110	580	5.54		
(-3 ft)	lb	*6260	*6260	*6440	3200	*4190	2050	*3000	1460	*2450	1280	(18.2)		
-2.0 m	kg	*3980	2950	*2590	1460	*1690	930			*1110	760	4.70		
(-7 ft)	lb	*8770	6500	*5710	3220	*3730	2050			*2430	1680	(15.4)		

Boom : 2.9 m (9' 10") / Arm : 1.90 m (6' 3") / Bucket : 0.18m³ (0.24yd³) SAE heaped / Dozer blade up

Load point height m (ft)		Load radius								At max. reach				
		2.0 m (7 ft)		3.0 m (10 ft)		4.0 m (13 ft)		5.0 m (16 ft)		Capacity		Reach		
												m (ft)		
4.0 m	kg									*900	670	5.45		
(13 ft)	lb									*1980	1480	(17.9)		
3.0 m	kg							*950	*950	*950	750	*940	550	5.96
(10 ft)	lb							*2090	*2090	*2090	1650	*2070	1210	(19.6)
2.0 m	kg			*1470	*1470	*1220	1000	980	730	*980	500	6.19		
(7 ft)	lb			*3240	*3240	*2690	2200	*2430	1610	*2160	1100	(20.3)		
1.0 m	kg			2150	1470	1360	940	*1250	700	*1020	490	6.21		
(3 ft)	lb			4740	3240	3000	2070	*2760	1540	*2250	1080	(20.4)		
Ground	kg	*2000	*2000	2040	1370	1300	880	*1360	670	*1070	510	6.00		
Line	lb	*4410	*4410	4500	3020	2870	1940	*3000	1480	*2360	1120	(19.7)		
-1.0 m	kg	*2840	2660	2010	1340	1270	860	*1360	660	*1110	580	5.54		
(-3 ft)	lb	*6260	5860	4430	2950	2800	1900	*3000	1460	*2450	1280	(18.2)		
-2.0 m	kg	*3980	2700	2020	1350	1280	860			*1110	760	4.70		
(-7 ft)	lb	*8770	5950	4450	2980	2820	1900			*2430	1680	(15.4)		

1. Lifting capacity is based on ISO 10567.

2. Lifting capacity of the Robex Series does not exceed 75% of the tipping load with the machine on firm, level ground or 87% of full hydraulic capacity.

3. The load point is a hook located on the back of the bucket.

4. (*) indicates the load limited by hydraulic capacity.

Lifting Capacity

R60CR-9 DIMENSIONS

Unit : mm (ft.in)

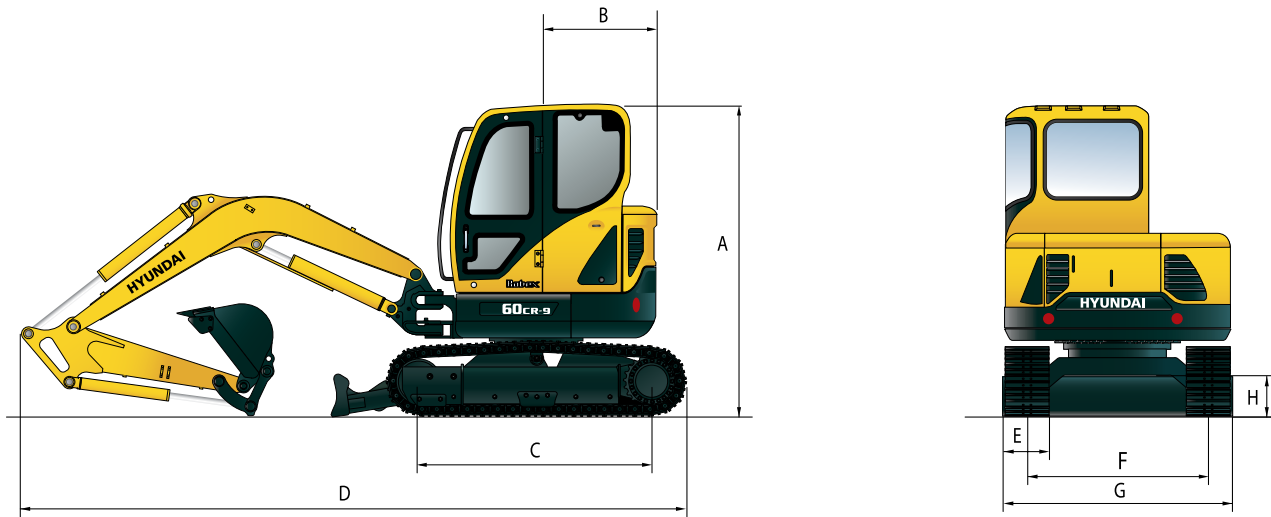

mm (ft.in)

A Overall height of cab	2,550 (8' 4")	E Track shoe width	Steel	380 (1' 3")
B Tail swing radius	1,080 (3' 7")		Rubber	400 (1' 4")
C Tumbler distance	1,990 (6' 6")	F Track gauge	1,600 (5' 3")	
D Overall length	5,600 (18' 4")	G Overall width	2,000 (6' 7")	
		H Ground clearance	380 (1' 3")	

Dimensions & Working Range

R60CR-9 WORKING RANGE

Unit : mm (ft.in)

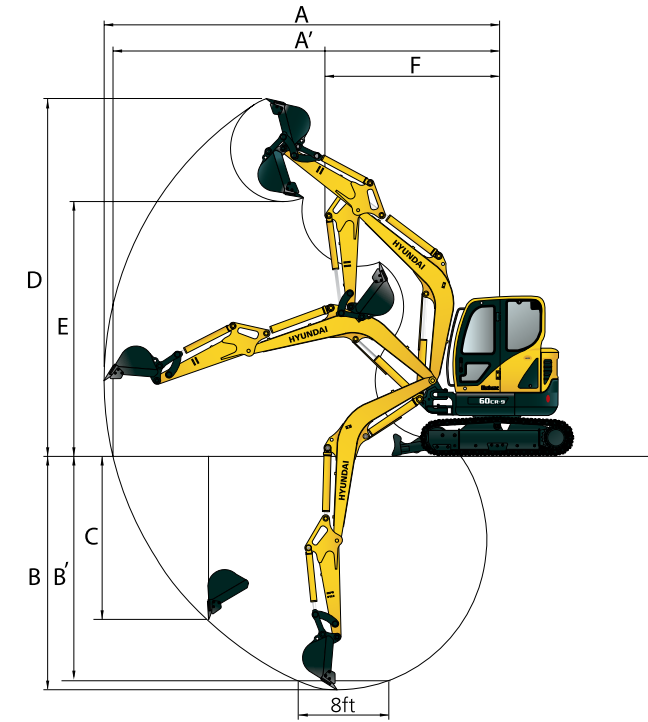

Unit : mm (ft.in)

Boom length	2,900 (9' 6")	
Arm length	1,480 (4' 10")	1,900 (6' 3")
A Max. digging reach	6,150 (20' 2")	6,480 (21' 3")
A' Max. digging reach on ground	6,010 (19' 9")	6,350 (20' 10")
B Max. digging depth	3,570 (11' 9")	3,990 (13' 1")
B' Max. digging depth (8ft level)	3,160 (10' 5")	3,620 (11' 11")
C Max. vertical wall digging depth	3,040 (9' 12")	3,360 (11' 0")
D Max. digging height	5,680 (18' 8")	5,850 (19' 2")
E Max. dumping height	3,930 (12' 11")	4,100 (13' 5")
F Tail swing radius	2,420 (7' 11")	2,510 (8' 3")